

BVX-200

Fume Extraction System



BVX-200 System User Guide..... page 3



www.okinternational.com

Operations Manual & User Guide

Congratulations on your purchase of the BVX-200 Fume Extraction System. It is designed to protect your health from hazardous and irritating air pollution you may have at your work area. It has been designed and manufactured to the highest quality standards.

This document has been prepared to guide you with the setup, operation, and user maintenance of your system. We recommend that you review it to optimize performance and for your safety.

Contents	Page No.
-----------------	-----------------

1.0 Please Observe The Following

1.1 Emphasized Section	4
1.2 For Your Safety	4
1.3 Unpacking and Inspection.....	5
1.4 Items Supplied.....	5
1.5 Features	5
1.6 Usage	6

2.0 Description.....	7
----------------------	---

3.0 Technical Data	8
--------------------------	---

4.0 Installation.....	8
-----------------------	---

5.0 Maintenance and Cleaning.....	9
-----------------------------------	---

6.0 Ambient Temperature Alarm Calibration	12
---	----

7.0 Troubleshooting	13
---------------------------	----

8.0 Part Numbers	13
------------------------	----

9.0 Warranty	14
--------------------	----

10.0 Contact Information	15
--------------------------------	----

1.0 Please Observe The Following

1.1 Emphasized Sections

Warning!

Refers to safety regulations and requires safety measures that protect the operator or other persons from injury.

Caution!













Emphasizes what must be done or avoided so that the unit or other property is not damaged.

Note:

Gives recommendations for better handling of the unit during operation or adjustment as well as for service activities.

1.2 For Your Safety

Warning!

-  For safe and successful operation of the unit, read these instructions completely. If the instructions are not observed, the manufacturer can assume no responsibility. Retain this manual for future reference.
-  Consult your "safety department" when using the unit on flammable gases. This unit is not explosion safe and can **only** be used for the extraction of vapors, which have concentration levels well below the lower explosive limits.
-  Do not use the unit to extract corrosive substances.
-  Do not expose the connecting cable to heat, oil, or sharp edges.
-  Make sure the unit stands stable and secure.
-  Use only original equipment filters.
-  Do not operate the unit without filter inserts. Contaminants in the extracted air will damage the blower.
-  Always disconnect the power supply before servicing the unit.
-  Never cover exhaust openings.
-  Never cover both air inlet openings simultaneously.
-  **Exception:** One opening may be sealed off for single station operation.
-  This system is equipped with automatic reset overload protection, which may cause the unit to restart automatically.
-  Observe general safety regulations for the handling of chemicals such as adhesives and sealants. Observe the manufacturer's instructions as stated in the Material Safety Data Sheet (MSDS).



While under warranty, the unit may be repaired only by an Authorized OK International Service Representative.

1.3 Unpacking and Inspection

Carefully unpack the Fume Extraction System and examine the items contained in the Carton. Inspect the unit for any damage that might have occurred in transit. If such damage is present, notify the carrier immediately. Claims for damage must be made by the consignee to the carrier and should be reported to the manufacturer.

1.4 Items supplied

- 1 Filter Unit with filters installed
- 1 Remote Start/Stop Button
- 1 Power Cord
- 1 Operating Manual

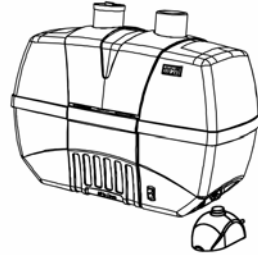

1.5 Features

- Efficient motor with “soft-start” feature
- Optional, remote Start/Stop switch
- Audible alarm to indicate blocked filters
- Low noise level
- High suction force and airflow
- Compact and portable
- HEPA Efficiency at 99.95% (Model BVX-201)
- Deep-bed gas filter option (Model BVX-203)
- Connects to 50mm(2”) or 63mm(2.5”) hoses or exhaust arms
- ESD safe housing
- UL & CSA listed, CE certified

1.6 Usage

The Fume Extraction System is a portable, two-station filtration system for the removal of fumes, light dust or vapors at the work place. The filter set supplied with the filter unit depends on the model ordered.

Model BVX-201 supplied with a pre-filter and a main filter. The main-filter is a combo-filter consisting of a HEPA filter with an efficiency of 99.95% at 0.3 micron and an activated carbon filter. This model is designed for applications such as solder fumes from solder irons, solder pots, etc.

Model BVX-203 supplied with a pre-filter and a deep-bed gas filter (activated carbon). This model is designed for applications such as cleaning with solvents, conformal coating, etc.

⚠ Warning! Consult your “safety department” when using the unit on flammable gases. This unit is not explosion safe and only used for the extraction of vapors, which have concentration levels well below the lower explosive limits.

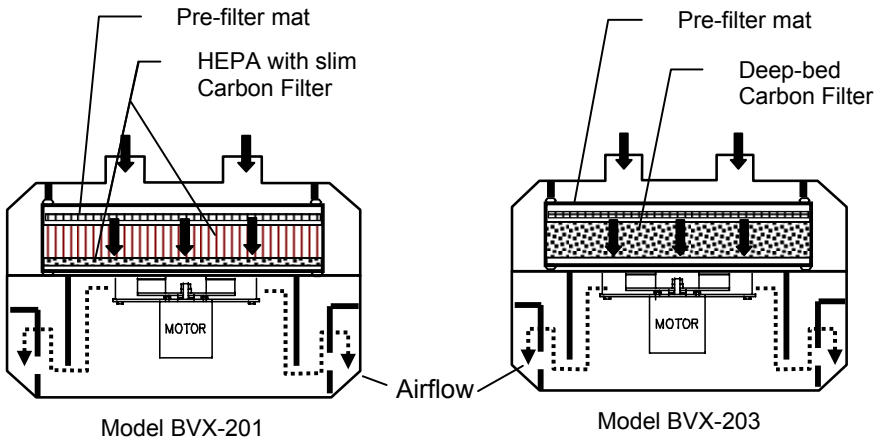

2.0 Description

2.1 Operating Elements and Construction

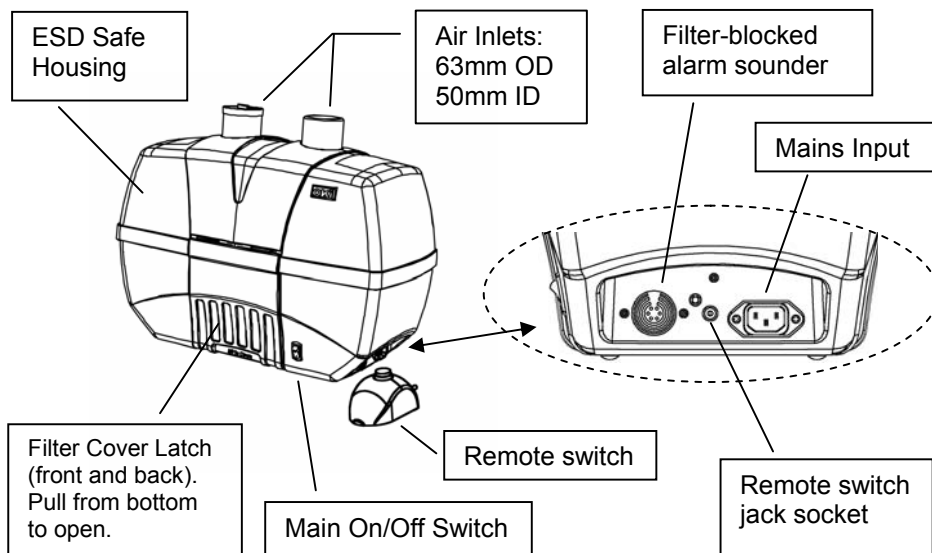

2.2 Theory of Operation

The efficient removal of hazardous fumes at your workplace is a two-step process: fume capture and filtration. The filter unit is supplied with a set of filters already installed.

To capture the fumes, OK International recommends use of optional exhaust arms and accessories (purchased separately). The exhaust arms need to be set up properly (instructions supplied with exhaust arms) and the nozzle positioned in a way to optimize fume capture.

Air extracted from your work area will be purified when passing through the filters inside the unit and is then returned into your work area.

Should the filters become blocked an alarm will start to sound. See section 5.4 for filter replacement procedures.

Contact your local OK International representative if there are any questions regarding the proper selection of filters for your application.

3.0 Technical Data

Maximum airflow, free blowing.....	250m ³ /h (150cfm)
Flow rate	2 x 75 m ³ /h (45cfm)
Static pressure	850 Pa (3.5"WC)
Noise level (approx.)	< 55dBA
Voltage	100 – 240 VAC, 1 phase
Frequency	50-60 Hz
Motor rating.....	85 Watts
Safety compliance.....	UL, CSA, CE
Dimensions W/D/Hmm.....	508 x 254 x 388
Dimensions W/D/H in.....	20" x 10" x 15.3"
Weight (approx.).....	20 lbs. / 9 kg

4.0 Installation

Remove the BVX-200 Fume Extraction System from packing materials and place on the floor under workbench or near your work area where fume extraction is required. Make sure you have access to the unit for filter maintenance.

Connect the units' power cord into the outlet on the side of the system. Plug the power cord into a grounded wall socket.

 **Warning!** To provide protection against the risk of electrical shock, connect to properly grounded outlets only.

Connect the unit to arms/hose as per installation instructions.

To power up system, depress the power switch, located on the bottom right of the unit. The operator can expect a delay of a few seconds before hearing the motor running. This is due to the built-in motor "Soft-start" feature.

If utilized, connect the supplied remote Start/Stop switch to the system and site the switch in a convenient position on the workbench. We recommend that this switch be used for your convenience; the 'On' light will indicate the BVX-200 motors' On/Off state and will ease switching without the need to bend under the workbench.

Position the extraction arms to optimize fume capture.

Follow maintenance procedures on next page.

5.0 Maintenance and Cleaning

5.1 Filter Unit - Maintenance and Safety

The BVX-200 Fume Extraction System is designed with low maintenance in mind. The housing is ESD safe plastic. Here are a few tips to keep your system running in top shape:

To clean, use a light wipe with a gentle cleaner to prevent build up of particulate and flux residue (be sure unit is turned off while cleaning).



Do not block both of the inlets or exhaust outlets; this will cause:

- the operating temperature of the system to rise
- a false filter-block alarm,
- potential damage to the unit,
- a drop in performance.



Do not defeat the filter interlock switch. Running the system without a filter will allow particulates and flux residue to adhere to the blower, decreasing the life of the system and increasing noise.



Do not lift system while operating.



Be sure to handle filters with care.

5.2 Filter Replacement Timing

Model BVX-201

As fumes are filtered inside the unit, any particulates captured will, over time, start to clog the filter. The coarse particles are collected in the pre-filter while fine particles will be collected in the HEPA filter. This clogging will result in a reduction of the airflow, which may reduce the amount of fumes extracted from the work area. Once the filters start to become blocked an audible alarm will sound in the main unit. This is to signify that filter replacement is required.

Initially replace the pre-filter only. If this does not silence the alarm, then replace the main filter too.

Dependant on application, pre-filters should be replaced approximately three to five times as frequently as the main filter. We recommend that a stock of replacement filters be kept for optimal extraction performance and minimum down-time. Part Numbers are shown in section 8.2 of this User Guide.

⚠ Warning! Do not attempt to clean filters. Attempted cleaning can damage filters and cause potential risk to health and equipment.

👉 Note: OK International recommends replacement of filters annually as a minimum. **Use only original replacement filters.**

Model BVX-203

This model features a deep-bed gas filter, which generally does not clog and reduce airflow as common with HEPA filters. Replace both filters; pre-filter and carbon filter as soon as odors become noticeable.

👉 Note: Replace filters at least every 6 months, as most gas-phase filter media achieve saturation by adsorbing moisture from ambient air. **Use only original replacement filters.**

5.3 Safety Interlock

The safety switch is an interlock which turns off the fan when the main filter is removed and when the fan inlet opening is exposed. The safety switch also prevents the system from operating without filters which would allow impurities to contaminate the internal unit.

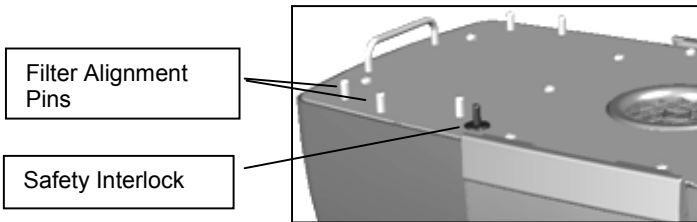

⚠ WARNING! Do not bypass safety interlock. Bypassing safety interlock could result in injury to persons.

5.4 Filter Replacement Procedure:

1. Turn unit off and disconnect the power cord.
2. Unlatch both filter cover catches and remove the filter cover. (see below)
3. Replace the filters. (Pre-filter/main filter). Ensure the main filter is placed inside the alignment pins so that the interlock switch is depressed.
4. Replace the filter cover and ensure a proper fit to the bottom housing. Hook both latches into the filter cover and press down carefully to engage each latch to the base.

! Caution! *Do not use force. If latches do not close, check proper seating of filter cover on bottom housing.*

5. Reconnect power cord and turn system on.
6. If the unit does not operate, refer to the troubleshooting section.

 **Notice:** Always use new replacement filters!

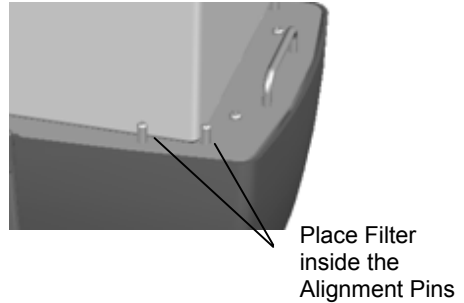
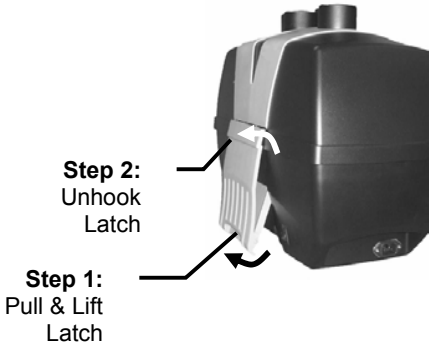

5.5 Filter Disposal

The gas filter collects some organic materials. Note: care in disposal may be required. A used filter may also contain toxic materials and inhalation of dust particles or exposure to skin must be avoided. Please consult the MSDS Sheets for the material used at your facility and follow the prescribed handling instructions.

6.0 Ambient Temperature Alarm Calibration

The BVX-200 filter-block alarm is factory calibrated to a specific temperature setting and will, for most users, require no adjustment. However, users in warmer climates may need to adjust the BVX-200 temperature setting to prevent false alarms. Details are available from your local OK International representative.

- 1 Assemble the BVX-200 as per the User Guide. Both the remote switch and the main power switch should be in the 'Off' position.
- 2 Switch On the main unit and press the remote switch. The remote switch LED will light when powered. The unit will run and you will hear the alarm sound momentarily but then stop while the motor continues to run. Allow the motor to run for at least 10 minutes to attain normal operating temperature.
- 3 With one inlet port already blocked, place a block plate with a 6mm Ø hole over the other air inlet and listen for the alarm tone. If heard, go to next step; if not, remove the plastic blanking-plug and turn the potentiometer counterclockwise until the alarm tone is heard.
- 4 Replace the 6mm Ø hole blank with a 15mm Ø one. If the alarm still sounds, gently adjust the potentiometer by turning screwdriver clockwise until the alarm can no longer be heard. Refit the blanking plug once the correct setting is obtained.



To make your own block-plates:

- A standard CD has a 15mm Ø hole at its centre.
- A paper hole-punch may be used on stiff card to make a hole that is approximately 6mm.

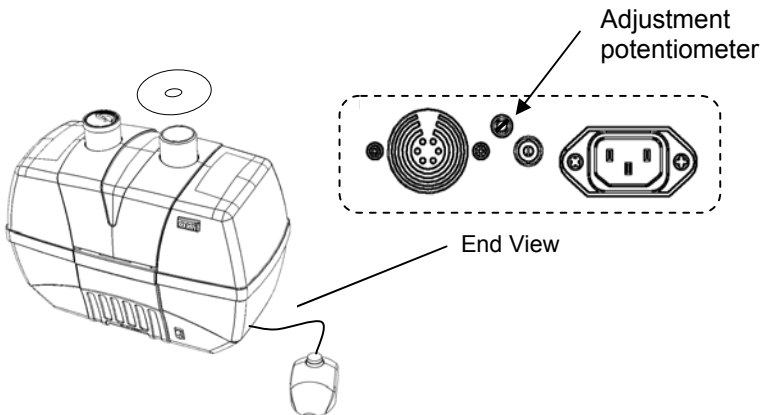

7.0 Troubleshooting

Problem	Possible Cause	Check
No air flow	No Power	Check On/Off Switch Check power outlet Check power cord Check filter is present Check safety interlock switch
Poor performance	Air leak	Check hose/arm for leaks Check hose/arm for proper installation Check hose/arm for partial clogging

8.0 Part Numbers

8.1 Filter Units

BVX-201 Filter Unit for 2 Station, Pre / HEPA / Gas

BVX-203..... Filter Unit for 2 Station, Pre / Deep Bed Gas

8.2 Replacement Filters	Model BVX-201	Model BVX-203
FP-BVX200 Pre-Filter (Pack of 5)	yes	yes
FG-BVX200 Deep-Bed Gas Filter	no	yes
FM-BVX200 Main Filter, HEPA 99.95% / Carbon	yes	no

8.3 Optional Kits and Accessories

BVX-ARM-K1...Kit consisting of BVX-ARM, BVX-CH01, BVX-TB01

BVX-ARMLExhaust Arm, flexible, 1220mm (48") x 50mm (2"), ESD Safe

BVX-ARMExhaust Arm, flexible, 710mm (28") x 50mm (2"), ESD Safe.

BVX-TB01 Table Bracket with 2 each C-Clamps

BVX-CH01 Connection Hose, 1800mm (6') x 50mm (2")

BVX-CH02 Connection Hose, 3600mm (12') x 50mm (2")

9.0 WARRANTY

Please visit OK International's products web page (www.okinternational.com) where you will find available information on systems, accessories, technical notes, and more. You may also contact your local representative for pricing and availability.

OK International warrants the BVX-200 Series against any defects in materials or workmanship for one (1) year from the date of purchase by the original owner. This Warranty excludes normal maintenance and shall not apply to any opened, misused, abused, altered or damaged items. If the product should become defective within the warranty period, OK International will repair or replace it free of charge at its sole option. The repaired or replacement item(s) will be shipped, freight prepaid, to the original purchaser. The warranty period will start from the date of purchase. If the date of purchase cannot be substantiated the date of manufacture will be used as the start of the warranty period.

For the repair or return of a unit a Return Material Authorization Number (RMA #) needs to be obtained. Please see next page for contact details.

10.0 CONTACT INFORMATION

For Sales & Customer Care

<p>North America OK International 12151 Monarch Street Garden Grove, CA 92841 USA Tel: +1 714-799-9910 Fax: +1 714-799-9533 www.okinternational.com</p>	
<p>Europe OK International Ltd. Eagle Close, Chandlers Ford Hampshire, SO53 4NF U.K. Tel: +44 (0) 23 8048 9100 Fax: +44 (0) 23 8048 9109</p>	<p>China OK International 4 Floor West, 1st Building, Tingwe Industrial Park, 6 Liufang Road Baocheng 67 th Area, Baofan District Shenzhen, Guangdong, 518101, PRC Tel: +86-755-2759-9247</p>